

PELI® CASE

Référence	Dim. Intérieures (en mm)	Couv/base	Dim. Extérieures (en mm)	Poids à vide	Coloris
1120	184 x 121 x 78	13 / 65	206 x 167 x 90	0,54	■ ■ ■
1150	208 x 144 x 92	19 / 73	232 x 192 x 111	0,81	■ ■ ■ ■
1200	235 x 181 x 105	30 / 74	270 x 246 x 124	1,23	■ ■ ■ ■ ■
1300	251 x 178 x 156	30 / 125	270 x 246 x 174	1,43	■ ■ ■ ■ ■
1400	300 x 225 x 132	30 / 102	340 x 295 x 152	1,84	■ ■ ■ ■ ■
1450	371 x 259 x 152	44 / 108	407 x 330 x 175	2,55	■ ■ ■ ■ ■
1500	426 x 284 x 156	46 / 109	470 x 357 x 176	2,96	■ ■ ■ ■ ■
1510	502 x 279 x 194	45 / 147	559 x 351 x 229	5,44	■ ■
1520	454 x 324 x 172	46 / 125	486 x 392 x 192	3,76	■ ■ ■ ■ ■
1550	468 x 356 x 194	44 / 149	524 x 429 x 206	4,9	■ ■ ■ ■ ■
1560	518 x 392 x 229	51 / 178	561 x 456 x 265	7,87	■ ■
1600	544 x 419 x 200	44 / 156	616 x 494 x 221	6,02	■ ■ ■ ■ ■
1610	551 x 422 x 268	52 / 216	628 x 498 x 303	9,26	■
1620	543 x 414 x 319	52 / 267	630 x 492 x 352	11,33	■
1630	704 x 533 x 394	83 / 308	795 x 615 x 444	14,35	■
1640	602 x 610 x 353	51 / 302	691 x 699 x 414	15,74	■
1650	724 x 441 x 267	47 / 219	781 x 521 x 295	13,47	■
1660	716 x 502 x 448	89 / 359	800 x 581 x 483	15,82	■
1690	763 x 636 x 407	73 / 308	848 x 723 x 463	15,74	■
0340	457 x 457 x 457	102 / 318	521 x 524 x 489	11,11	■
0350	508 x 508 x 508	127 / 381	572 x 570 x 540	12,03	■
0370	610 x 610 x 610	114 / 457	673 x 673 x 642	14,08	■
1700	908 x 343 x 133	44 / 89	969 x 406 x 155	7,45	■ ■
1720	1067 x 343 x 133	44 / 89	1127 x 406 x 155	7,92	■ ■
1730	863 x 609 x 317	63 / 254	952 x 689 x 365	13,61	■ ■ ■
1740	1040 x 328 x 308	65 / 243	1121 x 409 x 355	9,98	■
1750	1283 x 343 x 133	44 / 89	1347 x 407 x 156	10,91	■ ■



PELI® STORM

Référence	Dim. Intérieures (en mm)	Couv/base	Dim. Extérieures (en mm)	Poids à vide	Coloris
2050	241 x 190 x 108	38 / 70	300 x 249 x 119	1,22	■ ■ ■
2075	241 x 190 x 184	38 / 146	300 x 249 x 196	1,5	■ ■ ■
2100	330 x 234 x 152	51 / 102	361 x 289 x 165	1,91	■ ■ ■
2200	381 x 267 x 152	51 / 102	411 x 322 x 168	2,22	■ ■
2300	432 x 297 x 157	51 / 107	462 x 340 x 170	2,68	■ ■ ■
2306	432 x 160 x 157	51 / 107	432 x 213 x 170	1,95	■ ■
2370	462 x 307 x 132	43 / 89	508 x 373 x 147	2,59	■ ■
2400	457 x 330 x 170	51 / 119	487 x 386 x 185	2,95	■ ■ ■
2450	457 x 330 x 213	51 / 162	487 x 386 x 229	3,36	■ ■
2500	520 x 292 x 183	51 / 132	551 x 358 x 226	5,03	■ ■ ■
2600	508 x 355 x 196	51 / 145	538 x 406 x 211	3,86	■ ■ ■
2620	508 x 355 x 254	51 / 203	538 x 406 x 269	5,67	■ ■
2700	559 x 432 x 203	51 / 152	625 x 500 x 218	5,03	■ ■ ■
2720	559 x 432 x 254	51 / 203	625 x 500 x 297	7,62	■ ■ ■
2750	559 x 432 x 322	51 / 272	625 x 500 x 366	8,39	■ ■ ■
2875	571 x 536 x 289	51 / 239	632 x 602 x 333	9,12	■ ■
2950	736 x 457 x 267	51 / 216	795 x 518 x 310	9,43	■ ■ ■
2975	736 x 457 x 350	51 / 300	795 x 518 x 394	10,34	■ ■
3075	757 x 528 x 452	102 / 349	845 x 620 x 490	14,29	■ ■
3100	927 x 355 x 152	51 / 102	1011 x 419 x 170	6,89	■ ■
3200	1117 x 355 x 152	51 / 102	1198 x 419 x 170	8,03	■ ■
3220	1117 x 355 x 216	51 / 165	1198 x 419 x 234	9,25	■ ■
3300	1282 x 355 x 152	51 / 102	1366 x 419 x 170	8,66	■ ■



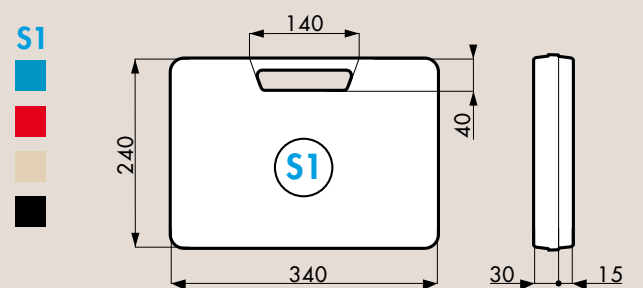
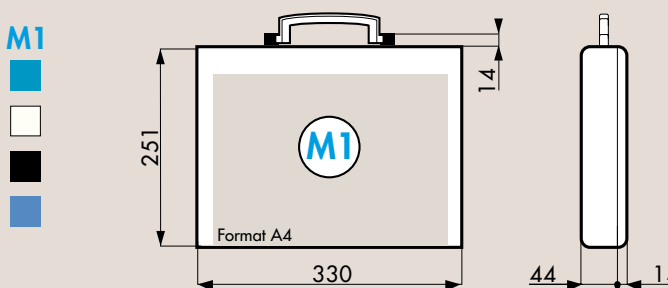
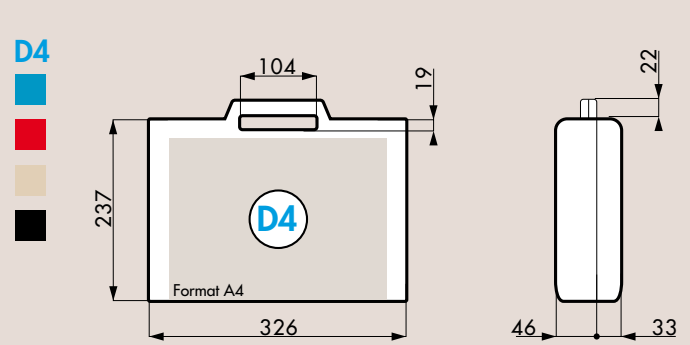
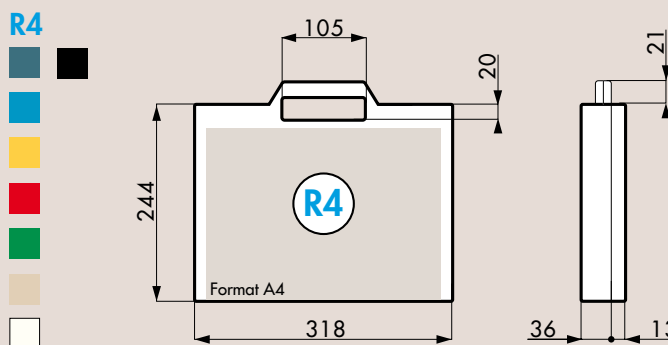
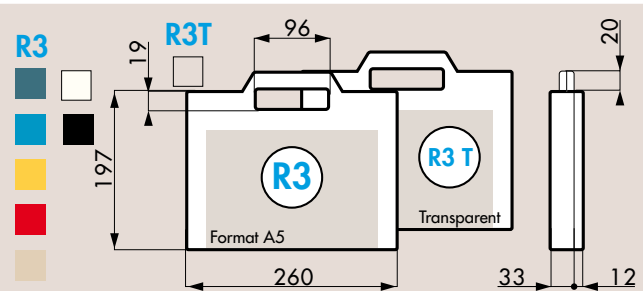
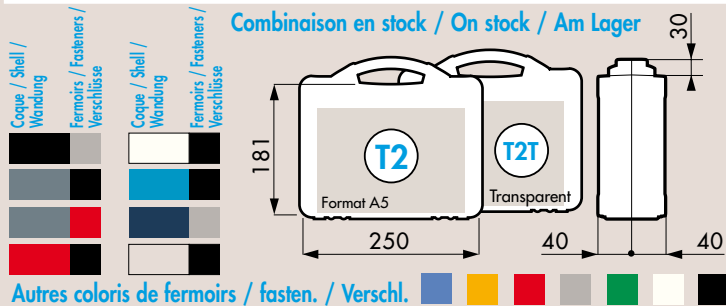
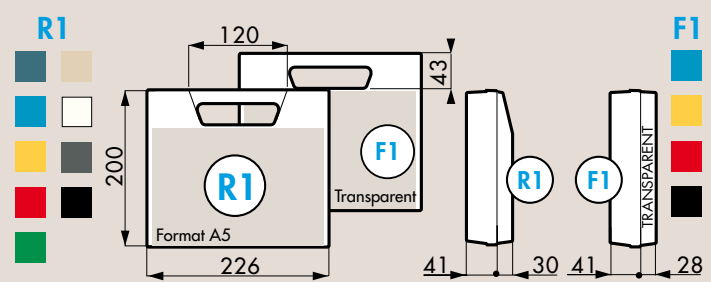
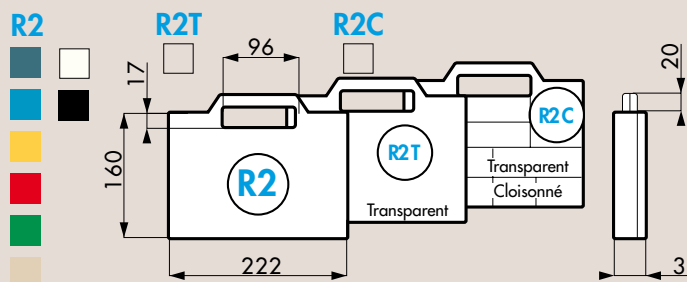
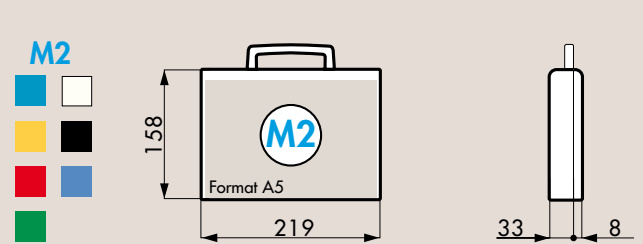
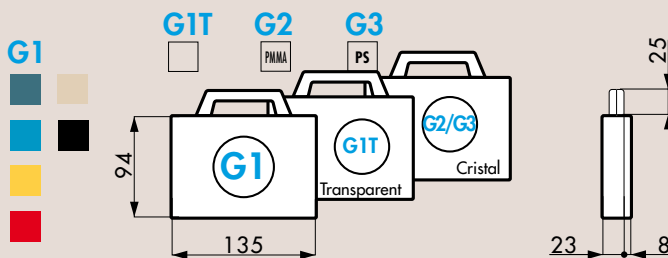
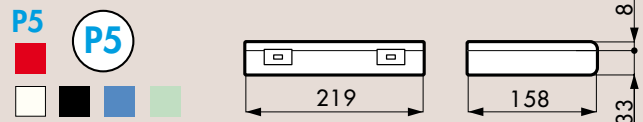
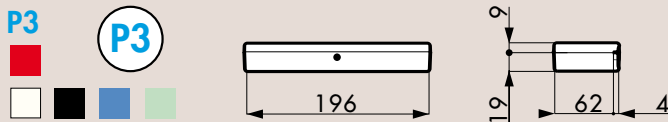
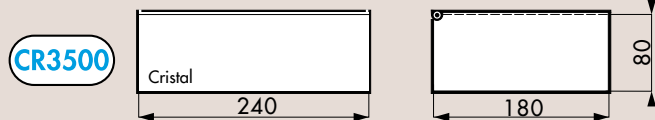
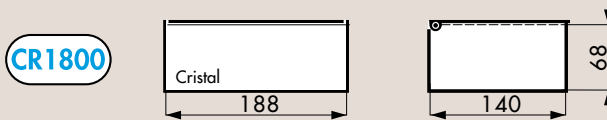
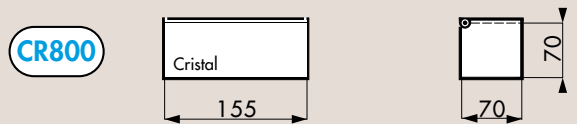
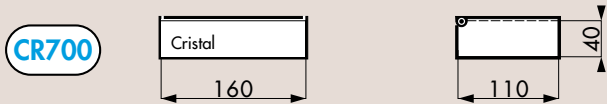

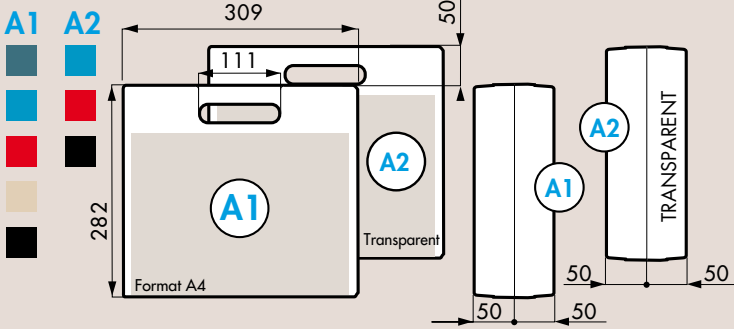
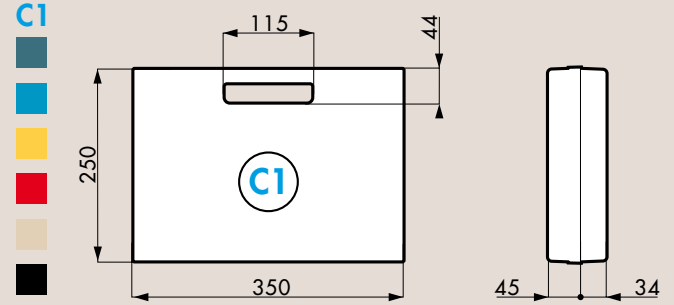
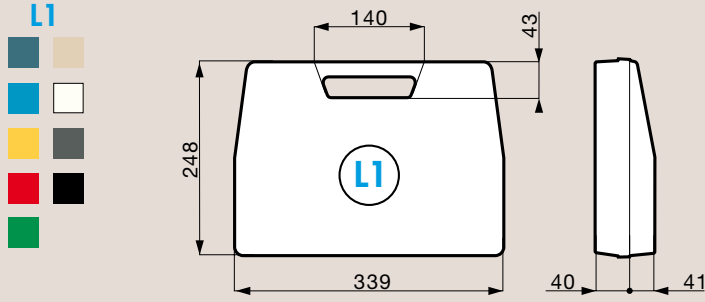

Combinaison en stock / On stock / Am Lager

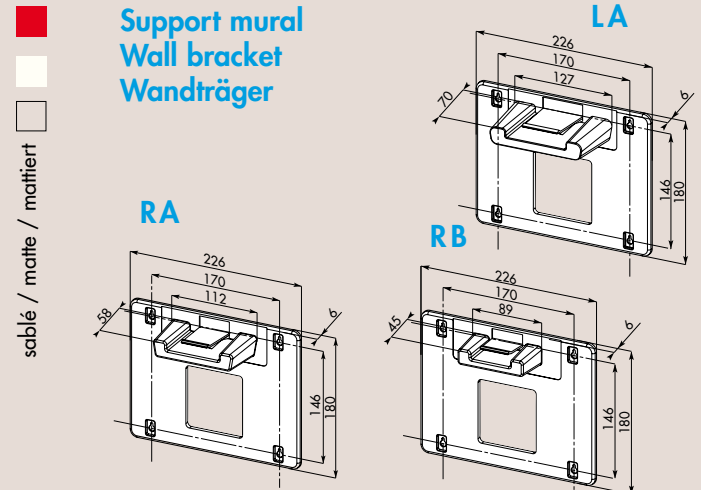
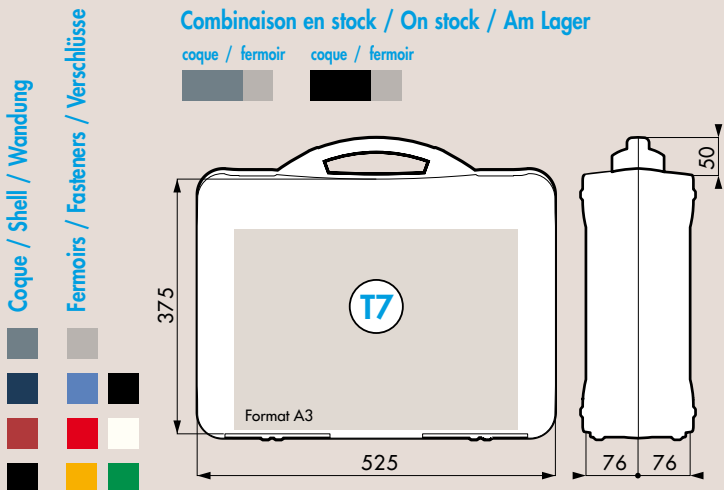
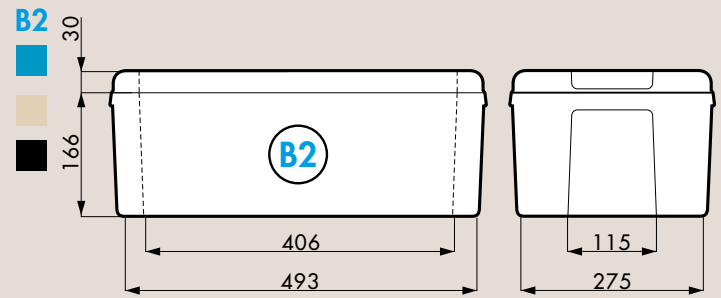
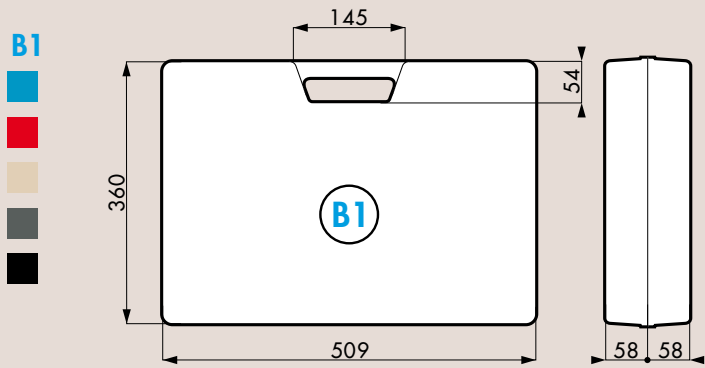
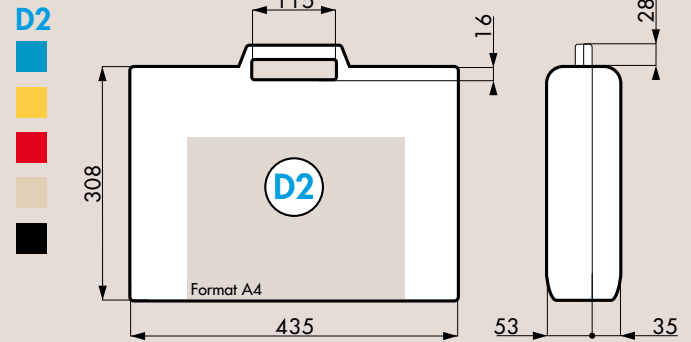
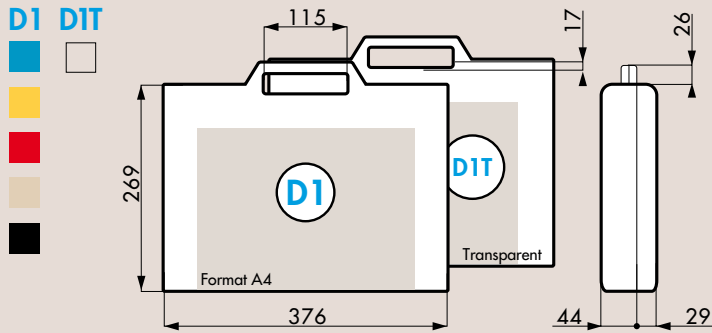
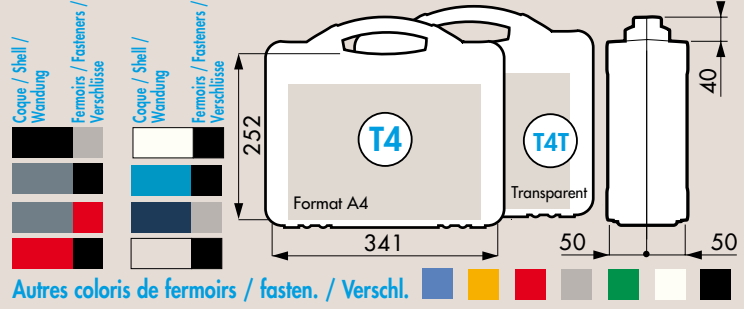

HEAVY

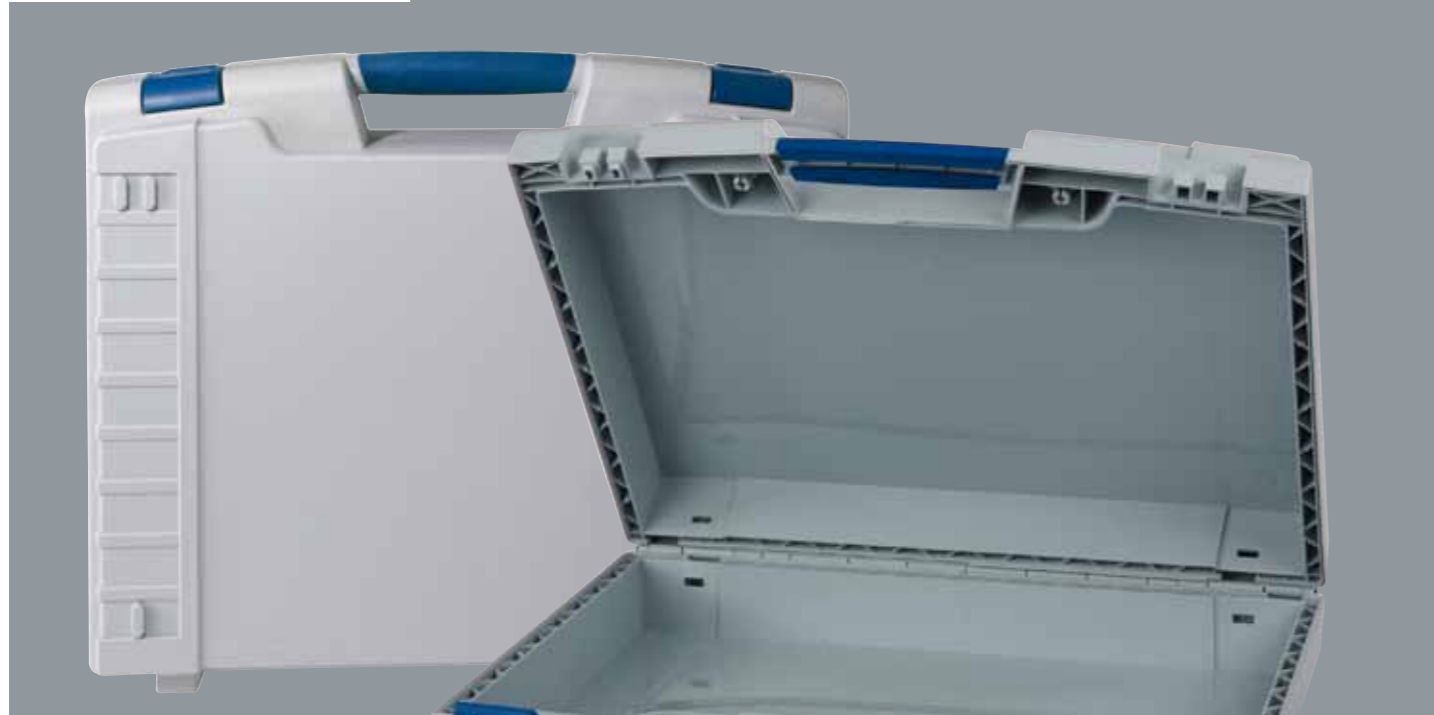

Die einmalige Konstruktion einer umlaufenden Sandwichbauweise verleiht HEAVY höchste Stabilität. Mit seinem modernen, kraftvollen Design und großem nutzbaren Volumen erfüllt er alle Ansprüche an einen funktionalen Koffer, der sich hervorragend in den verschiedensten Bereichen einsetzen lässt.

SANDWICHBAUWEISE: höchste Stabilität durch umlaufende doppelwandige Ausfuchung

Eine nach Bedarf einsetzbare Zwischenplatte ermöglicht es, auch das Kofferoberteil mit Inhalt zu füllen und somit den kompletten Innenraum zu nutzen. Durch die Ausstattung mit

SOFTTOUCH-GRIFF: gummierter Griff für optimalen Tragekomfort

Schaumstoff- oder Tiefzieheinlagen sowie individuellem Siebdruck kann der Koffer perfekt Ihren Produkten angepasst werden.

KNIEHEBELVERSCHLÜSSE: äußerst stabile Verschlüsse pressen die Kofferschalen sicher zusammen

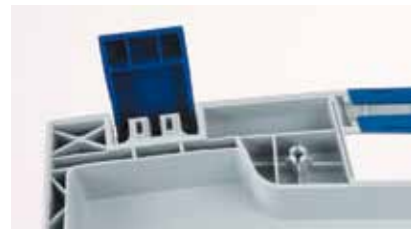

STELLFÜSSE: ausgeprägte Stellfüße für sicheren Stand



SCHARNIER: robustes durchgehendes Steckscharnier

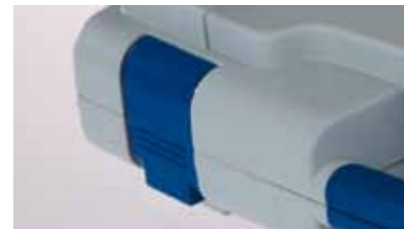

STAPELNOCKEN: integrierte Stapelnocken ermöglichen ein sicheres und rutschfreies Stapeln



Bemaßung für HEAVY

Standardfarben: schwarz, rot, silbergrau, dunkelblau, anthrazit

Verschlüsse und Griffe: schwarz, rot, silbergrau, dunkelblau, anthrazit

Zubehör: optional gelochte Zwischenplatte: anthrazit, silbergrau

Sonderfarben: auf Wunsch realisierbar

Material: Polypropylen

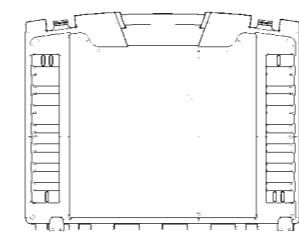

Artikel	Außenmaße (BxHxT)	Innenmaße (BixHixTi)
HEAVY 4001	300 x 275 x 82 mm	275 x 195 x 70 mm
HEAVY 4002	300 x 275 x 110 (70/40) mm	275 x 195 x 100 (65/35) mm
HEAVY 4003	300 x 275 x 140 mm	275 x 195 x 130 mm
HEAVY 4010	390 x 310 x 102 mm	360 x 228 x 90 mm
HEAVY 4012	390 x 310 x 147 (96/51) mm	360 x 228 x 135 (90/45) mm
HEAVY 4014	390 x 310 x 192 mm	360 x 228 x 180 mm
HEAVY 4028	500 x 420 x 125 mm	459 x 319 x 110 mm
HEAVY 4032	500 x 420 x 175 (113/63) mm	459 x 319 x 160 (105/55) mm
HEAVY 4036	500 x 420 x 225 mm	459 x 319 x 210 mm
HEAVY 4040	575 x 470 x 145 mm	528 x 368 x 130 mm
HEAVY 4044	575 x 470 x 205 (135/73) mm	528 x 368 x 190 (125/65) mm
HEAVY 4048	575 x 470 x 270 mm	528 x 368 x 250 mm

TEKNO



TEKNO ist die optimale Kofferlösung für höchste Anforderungen. Entwickelt und hergestellt von W. AG Funktion + Design, besticht TEKNO durch sein unverkennbares, modernes und klares Design. Diese hochwertige Verpackung bietet Ihren Produkten optimalen Schutz. Sicherer Transport und lange Haltbarkeit sind gewährleistet. TEKNO ist in 13 Größen lieferbar und punktet durch seine Vielseitigkeit in Farbe sowie Gestaltbarkeit der Oberfläche durch Siebdruck und individuelle Anpassung des Kofferinnenraumes.

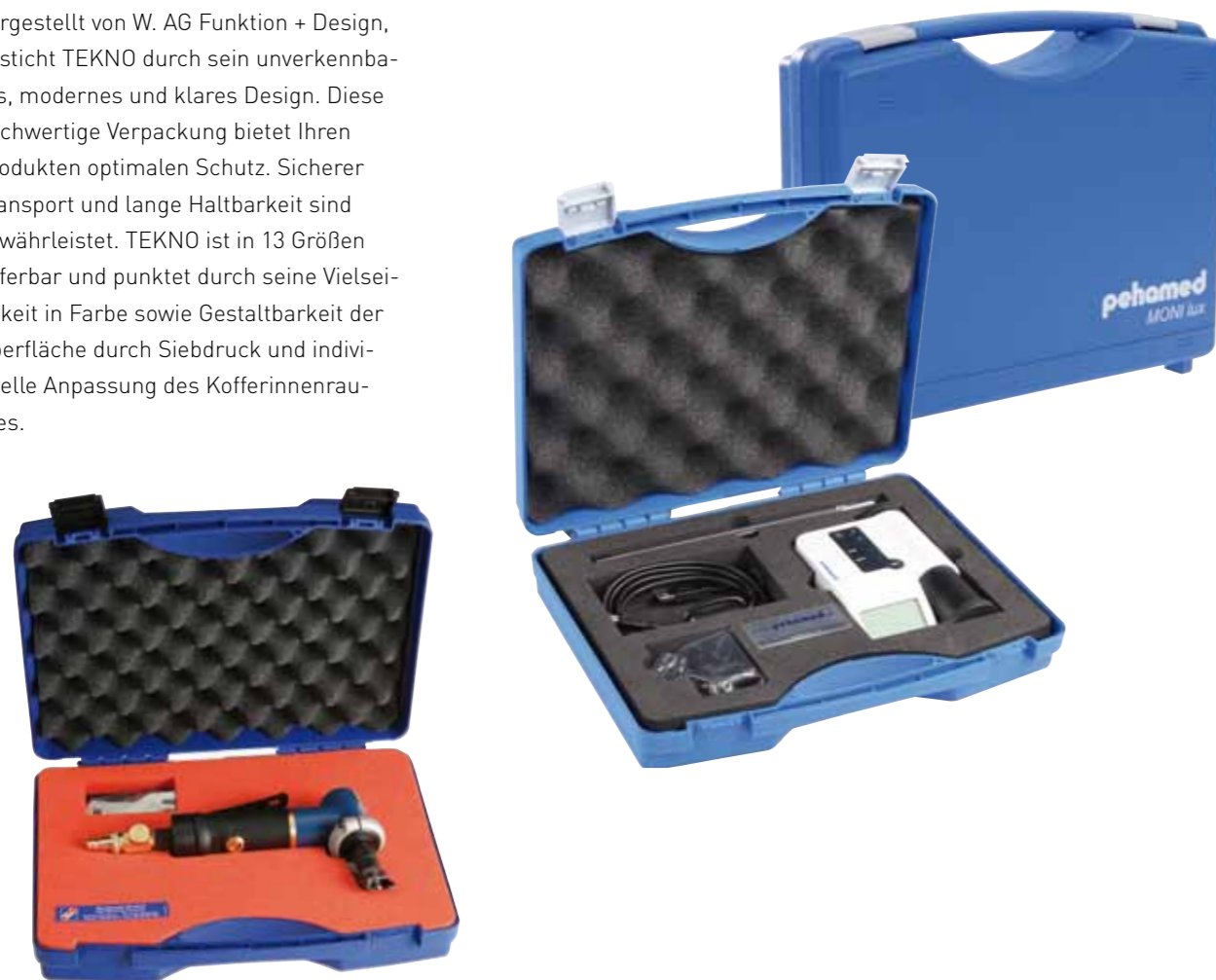

Bemaßung für TEKNO

Standardfarben:
schwarz, rot, blau, silbergrau, dunkelblau, anthrazit, transparent

Verschlüsse:
schwarz, rot, blau, silbergrau, gelb

Sonderfarben:
auf Wunsch realisierbar

Material:
Polypropylen

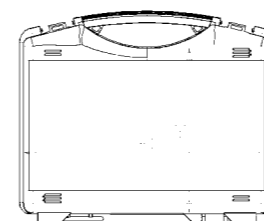

Artikel	Außenmaße (BxHxT)	Innenmaße (BixHixTi)
TEKNO 2002	235 x 185 x 48 mm	228 x 136 x 42 mm
TEKNO 2003S	255 x 210 x 48 mm	244 x 161 x 42 mm
TEKNO 2003M	255 x 210 x 60 (36/24) mm	244 x 161 x 54 (33/21) mm
TEKNO 2003	255 x 210 x 72 mm	244 x 161 x 66 mm
TEKNO 2004	275 x 230 x 83 mm	261 x 170 x 77 mm
TEKNO 2007	340 x 275 x 83 mm	326 x 222 x 77 mm
TEKNO 2008	340 x 275 x 123 (81/42) mm	326 x 222 x 116 (78/38) mm
TEKNO 2009	340 x 275 x 162 mm	326 x 222 x 156 mm
TEKNO 2009S	340 x 275 x 192 mm	326 x 222 x 186 mm
TEKNO 2011	395 x 295 x 106 mm	379 x 234 x 100 mm
TEKNO 2017	450 x 360 x 106 mm	434 x 289 x 100 mm
TEKNO 2018	450 x 360 x 123 (70/53) mm	434 x 289 x 116 (66/50) mm
TEKNO 2019	450 x 360 x 140 mm	434 x 289 x 132 mm